



*The New Way to*  
**Enjoy a Better Home**

**myALI**

FRAMING  
SOLUTIONS



Aluminium windows, french doors and bi-folds in anthracite grey.

**INTRODUCING OUR PRODUCTS**

Enhancing your home with a cutting-edge addition is made easy with our aluminium range. From our beautiful bi-fold doors through to our high performance curtain walling, you'll be able to find the perfect style for your property without the hassle. With a wide range of colours and styles on offer, it's never been easier to make your house a home.

OUR  
ALUMINIUM  
**PRODUCT  
RANGE**

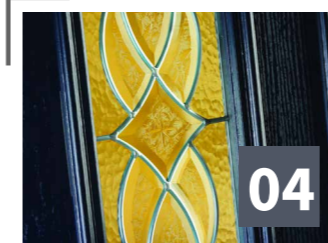

**GLAZING OPTIONS**

We offer a wide range of quality, made to measure glazing options, so you won't have to overlook glass as a decorative feature.

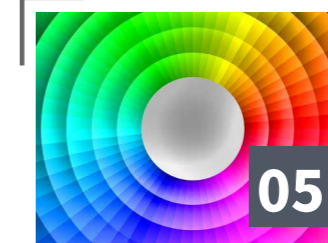

**COLOUR OPTIONS**

Colour can play a big role in determining the overall feel of your home; we're here to help you get the right option for your property.



**BI-FOLD DOORS**

Multi-panel function, customisable opening configuration and a seamless connection to your garden or property interior.

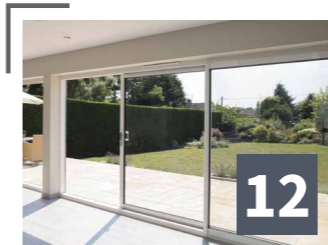

**PATIO DOORS**

Simple gliding motion, increased living space and generous glazing areas make these doors a wonderful addition to any home.



**FRENCH DOORS**

With a dual opening function, high performance profile and accessible design, these doors bring the classic continental charm into the modern age.



**RESIDENTIAL DOORS**

An update to the instantly recognisable design, our aluminium residential doors have been designed to be the ideal all-rounder.



**ALITHERM 300 WINDOWS**

Our Alitherm 300 window system is able to achieve a Window Energy 'A' rating, with U-Values as low as 1.5W/m²K.

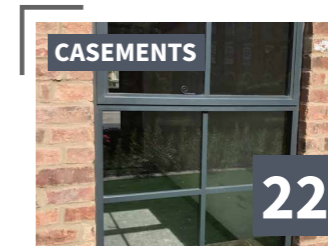

**HERITAGE WINDOWS**

The new solution for maintaining the classic looks of a steel framed window with a modern, thermally efficient aluminium frame.

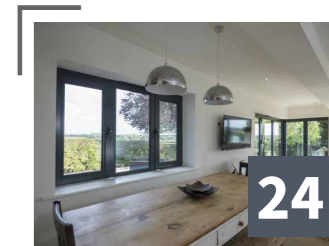

**TILT & TURN WINDOWS**

A multi-functional alternative to the casement window, tilt & turn windows offer a choice of opening options to suit your needs and your home.

*A Wide*  
**Range of Products,**  
*Defining Excellence*  
*From The Ground Up.*



Feature Georgian bar.

We offer a wide range of high quality glazing options, from ornate one-off lead and stained designs, through to the more traditional rectangular and diamond lead designs. You can also opt for privacy and solar glazing for increased comfort and performance across the year.

All of our glazing options are manufactured using premium materials and professional techniques, ensuring they uphold an outstanding level of structural integrity. This will allow you to enjoy complete peace of mind.

## GLAZING OPTIONS



FEATURE GEORGIAN BAR



INTERNAL GEORGIAN BAR

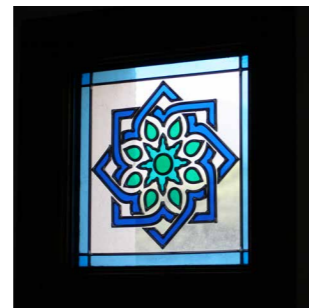

STAINED DESIGNS



LEAD & BEVEL DESIGNS

## PATTERNED GLASS

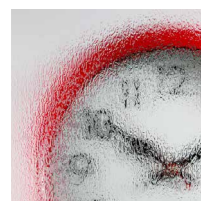

CONTORA

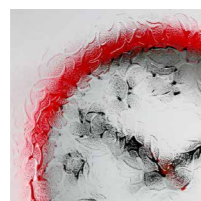

FLORIELLE



STIPPOLYTE



CHARCOAL STICKS

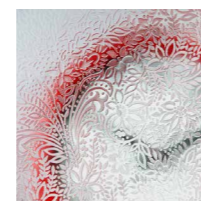

CHANTILLY



MINSTER

Other patterns are available

## Stand out with Colour

Our aluminium collection is available in a comprehensive range of colours, so you're sure to find the perfect match. All of our colours comprise of a highly durable, powder coated finish to ensure they don't lose their richness or fullness over the years.

As the options that we offer can be decorated with a range of finishes, our colour selection allows them to be seamlessly fitted into both modern and traditional homes alike. This means that you won't have to miss out on the cutting-edge design, no matter your property style.

Select a single colour or a dual colour combination by choosing a different colour for inside and out.

## Guaranteed for 25 years\*

\*The guarantee we offer covers the coated aluminium against peeling, powdering and blistering as well as chalking, fading, and loss of sheen. Please ask for full details of the guarantee.

Please notify us if the products are to be installed in hazardous environmental conditions as this will affect the guarantee.

The Sensation paint finish is difficult to reproduce in the printing process, as the textured finish takes on a "shimmer" effect in certain light and is unique when compared to the standard range of colours available in the market.

Please be aware that these colours come in different surface finishes as indicated. Please note that these colours are only intended as a guide and you should request a KL colour chart for a more accurate image.

### Classic Colour Range

Purple Red - Matt (KL002)

Sepia Brown - Matt (KL006)

Fir Green - Matt (KL004)

Grey Brown - Matt (KL007)

Jet Black - Matt (KL008)

Steel Blue - Matt (KL003)

Grey Aluminium - Metallic (KL013)

White Aluminium - Metallic (KL012)

Anthracite Grey - Matt (KL005)

Light Ivory - Matt (KL001)

Cream - Matt (KL011)

Pure White - Gloss (KL009)

Pure White - Matt (KL010)

### Sensations Colour Range

Mars Red (SEN 005)

Vulcan Black (SEN 014)

Olive Green (SEN 018)

Sand (SEN 003)

Dune (SEN 002)

Desert Grey (SEN 025)

Antique Green (SEN 012)

Antique Grey (SEN 015)

Sky Blue (SEN 009)

Silver Grey (SEN 017)

Frost White (SEN 022)

Velour White (SEN 001)



Anthracite grey bi-fold door.

**KEY FEATURES**

- Available in a variety of opening styles, stacked from the right or left, with or without a traffic door, please ask for details
- Available opening in or out
- Aesthetically designed soft rounded edges
- High security internal beads with multipoint locking
- 28mm double glazed units as standard: overall frame U-value of 1.7W/m<sup>2</sup>K
- Optional 36mm triple glazed units; overall frame U-value of 1.4W/m<sup>2</sup>K
- Optional main traffic door with access handle both sides
- Optional acoustic and barrier glazing
- Optional Secured by Design upgrade
- Optional integral blind units
- Optional low threshold

# BI-FOLD DOORS

**WHAT ARE BI-FOLD DOORS?**

Bi-fold doors consist of multiple panels that open in a sequence, allowing you to enjoy a generous opening. Their sleek and light design combines with a simple opening mechanism, ensuring easy and effective use every time.

28mm U-value  
**1.8W/m<sup>2</sup>K**  
Double Glazed

36mm U-Value  
**1.4W/m<sup>2</sup>K**  
Triple Glazed

Official Police Security Initiative  
**sternfenster**  
window systems  
**Secured by Design**  
Optional



Umbra grey aluminium bi-fold.



Our aluminium bi-fold doors are inherently customisable, available in a wide range of colours.

You can also choose from a wide selection of hardware options and panel counts to ensure you get the ideal fit for your home, perfectly suited to your requirements.

**A CUTTING-EDGE DOOR DESIGN, OFFERING A BEAUTIFULLY SEAMLESS CONNECTION BETWEEN YOUR HOME AND GARDEN.**





*Peace of Mind is* **Secured by Specialist Design**

Anthracite grey bi-fold doors.

## Upgrade to **Secured by Design**

We understand that security is important for helping you feel comfortable in your home, which is why we provide an optional upgrade to “Secured by Design” accreditation. These doors have been meticulously tested under Police specifications to ensure your home is better protected.



Official Police Security Initiative

**sternfenster**  
windowsystems

## CONFIGURATIONS

Complete list of configurations

### 1 PART BI-FOLD

1 0 1

1 1 0

### 2 PART BI-FOLD

2 0 2

2 1 1

2 2 0

### 3 PART BI-FOLD

3 0 3

3 1 2

3 2 1

3 3 0

### 4 PART BI-FOLD

4 0 4

4 1 3

4 2 2

4 3 1

4 4 0

### 5 PART BI-FOLD

5 0 5

5 1 4

5 2 3

5 3 2

5 4 1

5 5 0

### 6 PART BI-FOLD

6 0 6

6 1 5

6 2 4

6 3 3

6 4 2

6 5 1

6 6 0

### 7 PART BI-FOLD

7 0 7

7 1 6

7 2 5

7 3 4

7 4 3

7 5 2

7 6 1

7 7 0

### 8 PART BI-FOLD

8 0 8

8 1 7

8 2 6

8 3 5

8 4 4

8 5 3

8 6 2

8 7 1

8 8 0

## KEY TO CONFIGURATIONS

- Total number of doors
- Number of doors opening left
- Numbers of doors opening right
- 8 8 0 These configurations do not have an external handle

\*Low threshold are not recommended for external exposed locations



## BI-FOLD DIMENSIONS

Maximum height 2500mm, maximum sash width 1200mm, minimum sash width 700mm

1 door design	min width 600mm	max width 1287mm
2 door design	min width 1550mm	max width 2500mm
3 door design	min width 2260mm	max width 3700mm
4 door design	min width 3020mm	max width 4900mm
5 door design	min width 3680mm	max width 6100mm
6 door design	min width 4430mm	max width 7350mm
7 door design	min width 5100mm	max width 8500mm
8 door design	min width 5860mm	max width 9400mm

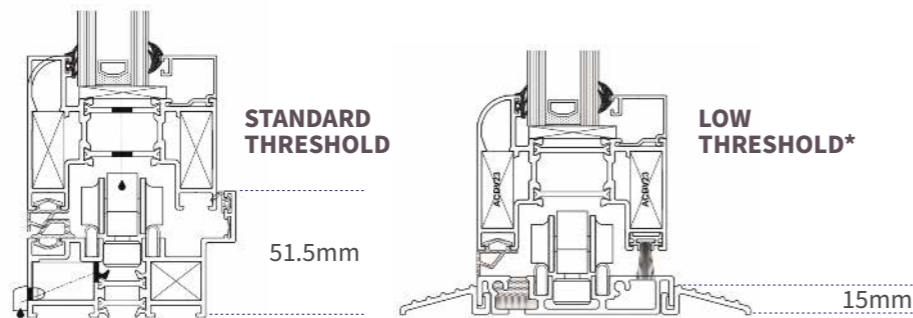

## CONFIGURATIONS

Examples of design configurations (open in or out)

Ⓜ Main door handle  
Ⓢ Slave door handle

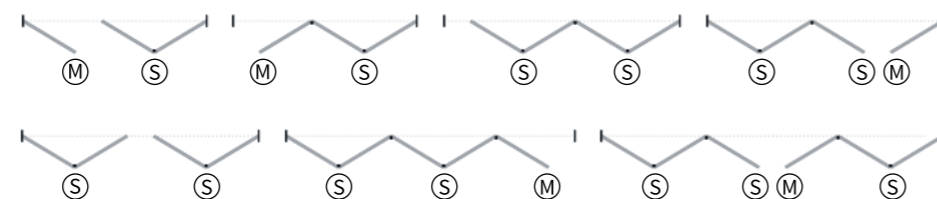

Not all options have an outside handle, please check the full list on the left. We also recommend that if you are in an exposed location that you do not have open in bi-folds.



## HIGH PERFORMANCE ALUMINIUM PROFILE

Free your living space with an intelligent, high quality aluminium profile with edges and finishes to match the aesthetics of your property.



## ENERGY EFFICIENCY

With 28mm double glazing, and 36mm triple glazing options available, our bi-fold doors provide superior performance in energy efficiency.



## FLEXIBLE CONFIGURATIONS

We offer a wide choice of configurations with aluminium bi-fold doors. You can choose left to right, right to left and anywhere in-between.



Aluminium patio doors in anthracite grey.

**KEY FEATURES**

- Available in 2,3,4,5 or 6 sliding sashes, with the moving sash on the inside
- Available with a double or triple track to enable multiple sliders to move in the same direction
- Contemporary design with square profiles
- High security internal beads with multipoint locking
- Lever handle with matching colour options
- 28mm double glazed units as standard; overall frame U-value of 1.7W/m<sup>2</sup>K
- Outer frame with upstand as standard, to allow the internal floor to finish flush with the track
- Optional 36mm triple glazed units; overall frame U-value of 1.4W/m<sup>2</sup>K
- Optional D shaped, or looped handles
- Optional upgrade to PAS 24 enhanced security standard
- Optional acoustic and barrier glazing



28mm U-value  
**1.8W/m<sup>2</sup>K**  
Double Glazed



36mm U-Value  
**1.5W/m<sup>2</sup>K**  
Triple Glazed

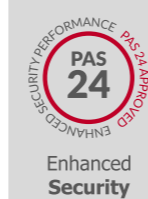

Enhanced  
**Security**



Grey aluminium patio doors.



Optional D handles.



# PATIO DOORS

**WHAT ARE PATIO DOORS?**

Patio doors feature a sliding door panel that operates on a horizontal axis. This means that they do not require a swing arc, allowing you to increase the overall living space that you have in the room that they are installed in.

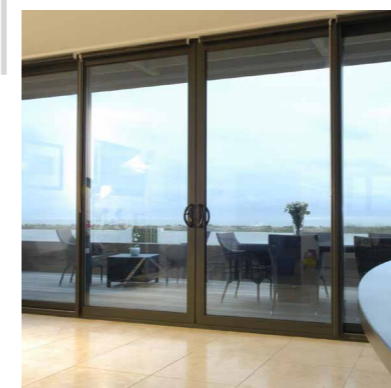

myALI patio doors feature a sleek, stylish aesthetic that is enhanced with high performance hardware and generous glazing areas. Achieving impressive levels of security and thermal efficiency, these doors outclass the traditional design.

**ENJOY SMOOTH OPERATION, LASTING QUALITY AND A BRIGHTER, MORE SPACIOUS HOME WITH THIS DESIGN.**

## CONFIGURATIONS

Complete list of configurations

### 2 DOOR OPTIONS – 2 TRACK FRAME

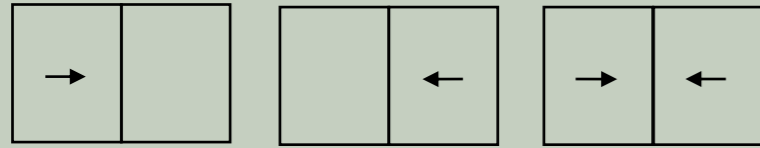

### 3 DOOR OPTIONS – 2 TRACK FRAME

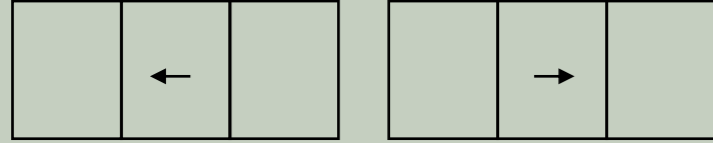

### 3 DOOR OPTIONS – 3 TRACK FRAME

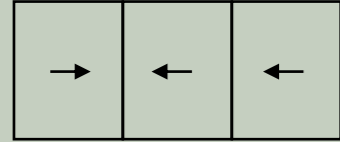
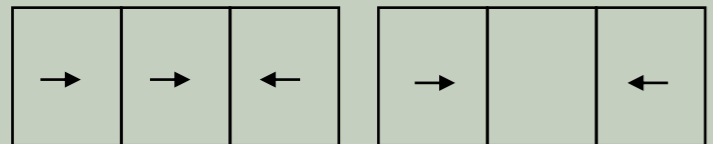
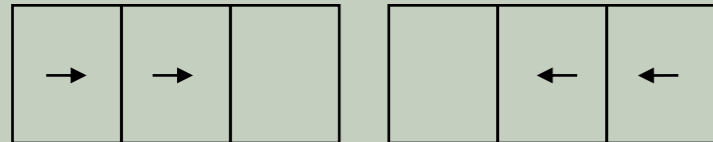

### 4 DOOR OPTIONS – 2 TRACK FRAME

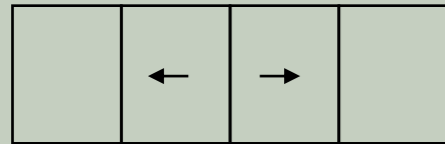

### 5 DOOR OPTIONS – 3 TRACK FRAME

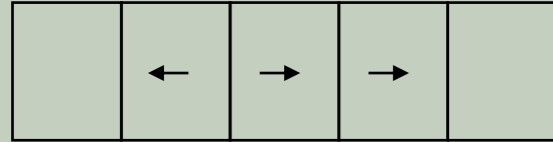

### 6 DOOR OPTIONS – 3 TRACK FRAME

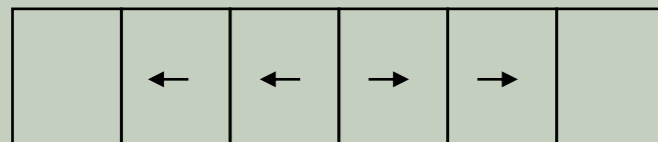

## PATIO SPECIFICATION

- Depending on the overall size of the opening there are different options for the number of door sashes and what configuration you want them sliding in.
- The maximum overall height of the patio is 2550mm.
- The maximum width of any door section is 2500mm.
- The maximum weight of any door section is 250kg.
- The larger the glass area, the thicker the glass required and the heavier the door. Access issues should also be considered with large pieces of glass.
- 4mm toughened glass should be used up to 1.6m<sup>2</sup>, 6mm toughened glass up to 2.2m<sup>2</sup> and either 8mm or 10mm glass after this. Please liaise with us regarding location and design so that we can advise you on the best glass.
- 4mm units = 20kg per m<sup>2</sup>, 6mm units = 30kg per m<sup>2</sup>, 8mm units = 40kg per m<sup>2</sup>, 10mm units = 50kg per m<sup>2</sup>, an unglazed sash at 2.5m x 2.5m weighs approx 25kg.
- There are a variety of different door styles that can be used, ranging from the slim 34mm section through to the 83mm section. As a general rule, the bigger the door and the more exposed location the bigger the section.
- Depending on the wind loading there are numerous strengthening bars that may need to be fitted onto the meeting styles to give structural stability.
- There are different door outer frames, the double track at 117.5mm wide (2 track frame) which is used as standard where you only have single doors moving in one direction and a triple track at 184.5mm wide (3 track frame) which is used when multiple doors are sliding, see configurations opposite.
- The outer frame has an internal upstand around the perimeter, at the cill section this allows the internal floor level to finish flush with it.

## PATIO DIMENSIONS

- Maximum overall width 7000mm.
- Maximum overall height 2550mm.
- Maximum sash size 2500mm x 2500mm.
- Standard double track width 117.5mm, triple track width 184.5mm, both with an upstand 52mm.



Multi-panel aluminium patio doors in anthracite grey

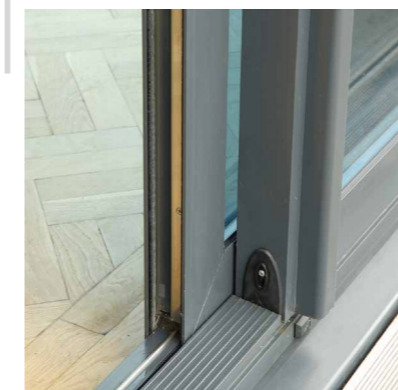

### MULTI-WHEELED ROLLING SYSTEM

An intelligently designed opening system allows our patio doors to offer complete ease of use that lasts.



### RANGE OF ACCESSORIES

We offer a range of handle and hinge options, allowing you to tailor your aluminium patio doors to your personal tastes.



### CUSTOMISABLE OPENINGS

To suit your home, you'll be able to choose the number of sliding panels that you have. You'll always get the perfect fit.





Aluminium French doors in anthracite grey.

#### KEY FEATURES

- Contemporary design with square sash and Ovolo frame
- High security internal beads with multipoint locking
- Maximum width of 2074mm and height of 2567mm
- Lever/lever double handles with matching colour options
- 28mm double glazed units as standard: overall frame U-value of 1.8W/m<sup>2</sup>K
- Optional upgrade to PAS 24 enhanced security standard
- Available open in or out
- Optional low threshold
- Optional leaded units
- High security flag hinges are used as standard, the ones shown are the optional none security hinges

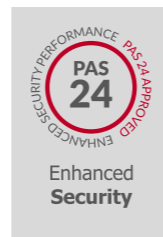

# FRENCH DOORS

#### WHAT ARE FRENCH DOORS?

French doors comprise of a dual panel design, which allows them to operate separately from each other. They also feature a 'flying mullion', which means that there is an unobstructed entrance when both of the doors are opened.



Aluminium French doors fitted with black lever handles.

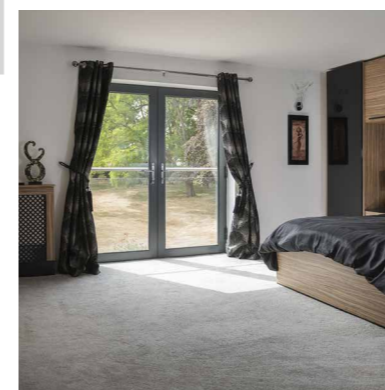

Our aluminium French doors can be fitted with a low threshold option to improve the accessibility of wheelchair and pushchair users, combining high security locking systems and a high performance profile to serve as a fantastic addition to any home.

These doors are available in a wide range of colours and finishes, allowing you to decorate your new addition in a style that is perfect for you and your property. You'll be able to stay loyal to the traditional aspects of this door design without missing out on modern quality.

**THE DEFINITIVE OPTION FOR THOSE LOOKING TO CAPTURE THE ESSENCE OF THE CONTINENT, ENHANCING THE FEEL OF ANY HOME.**



Contemporary aluminium door with panel and stainless steel bar handles and slam shut lock.

**KEY FEATURES**

- Contemporary aluminium profiles with square sash and Ovolo frame
- Range of aluminium door panels or glazed designs
- High security internal beads with multipoint locking
- Aluminium doors max width of 1067mm and height of 2507mm
- Lever/lever handles with matching colour options
- 28mm double glazed units as standard: overall frame U-value of 1.8W/m<sup>2</sup>K
- Full range of composite doors with PVC outer frames in various styles and colours
- Optional upgrade to PAS 24 enhanced security standard
- Available open in or out
- Optional low threshold

# RESIDENTIAL DOORS

**WHAT ARE RESIDENTIAL DOORS?**

Residential doors act as the focal point of any home, proving to be the main point of access for homeowners, family, friends, and visitors. They operate in the standard 'open in' or 'open out' function and can be customised in a number of ways.

28mm U-value **1.8W/m<sup>2</sup>K** Double Glazed

Enhanced Security



Contemporary aluminium door with heritage slam shut lock.

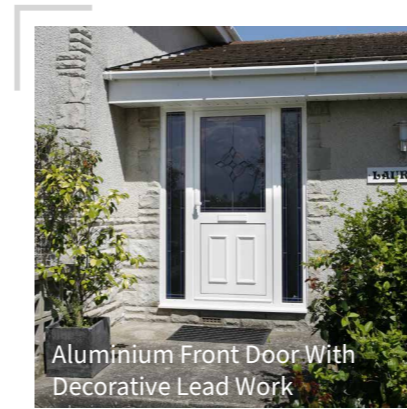

Aluminium Front Door With Decorative Lead Work

Recognised as a signature option for properties, residential doors have proven themselves to be an essential component of a warm, safe, and comfortable home. Our residential doors go one step further, offering market-leading standards of aesthetic, functionality, performance and design to achieve updated standards.



Due to their timeless appearance, these doors can be seamlessly installed into any style of property type. We offer a wide array of colours, finishes, and hardware options.

**A TRUSTED DESIGN, THESE DOORS ALLOW YOU TO ENJOY ALL THE BENEFITS OF TRADITIONAL VALUES IN A CUTTING-EDGE WAY.**



**KEY FEATURES**

- Traditional open out casement window with the elegance and styling of a timber product
- Contemporary styling for modern homes and offices
- Slim profiles to give maximum glass area, and beautiful site lines
- PAS24 compliant optional
- 70mm square outer frame
- Optional dummy vents to give equal glass sightlines
- Variety of handles with matching colour options
- Bi-directional espagnolette multi point locking for high security
- 28mm double glazed options: overall frame U-value 1.6/m2k, WER B

 <b>Air</b> 600Pa	 <b>Water</b> 1200Pa	 <b>Wind</b> 2400Pa
---	---	--

OUR CASEMENT WINDOW RANGE  
**ALITHERM 300**

**WHAT IS THE ALITHERM 300 RANGE?**

The Alitherm 300 is perfect for homeowners wanting high-performing, thermally efficient windows with great aesthetics and an excellent life span.

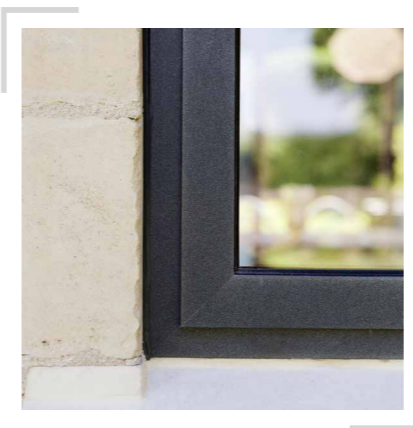

Make every detail perfect, with a wide range of colour options, matching a window to a home has never been easier.

**ENHANCE YOUR HOME WITH A CUTTING-EDGE DESIGN, BRINGING MUCH LOVED AND VALUED FEATURES INTO THE MODERN AGE.**



Alitherm 300 casement range.



**TRADITIONAL STYLING**  
Complimenting contemporary and traditional homes alike, the versatile Alitherm 300 provides a picture-perfect aesthetic. The ideal choice with its exceptional weather resistant qualities and low maintenance design.



**IMPRESSIVE PERFORMANCE**  
Enjoy a warmer, more comfortable home with exceptional energy performance. Our Alitherm 300 window system is able to achieve a Window Energy 'B' rating, with U-Values as low as 1.6W/m²K.





**HIGHLY DURABLE**  
Enjoy lasting quality with our aluminium windows. Highly durable, they will not rot, warp or discolour over time. Designed to meet the demands of today's modern home, these windows are incredibly low maintenance.



**KEY FEATURES**

- Outward opening casement windows with storm sash
- Very slim profiles to give maximum glass area
- Suitable for steel replacement windows in listed buildings
- External square bead to fixed panes with flat internal beading to opening lights
- 47mm frame depth
- 28mm double glazed units as standard: overall frame U-value of 1.7W/m<sup>2</sup>K, WER B
- Optional 36mm triple glazed units: overall frame U-value of 1.4W/m<sup>2</sup>K, WER A
- Bi-directional espagnolette multipoint locking
- Variety of handles with matching colour options

 <b>Air</b> 600Pa	 <b>Water</b> 600Pa	 <b>Wind</b> 2400Pa
---	--	--

OUR CASEMENT WINDOW RANGE

# HERITAGE WINDOWS

**WHAT ARE HERITAGE WINDOWS?**  
Heritage windows are designed to be built as a multi-part window, loyally capturing the look of the traditional window build. They are suited as a modern solution for refurbishment projects and period properties.



Our Heritage range of aluminium windows stands as the ideal solution for homeowners looking to maintain the character and charm of their property, utilising traditional designs to accommodate listed building renovations and refurbishment projects.

**BRING TRADITION TO YOUR PROPERTY WITH THE HERITAGE RANGE, INSPIRED BY GENERATIONS OF WINDOW DESIGN AND AESTHETIC.**



Agate grey Heritage casement windows.



**HERITAGE DESIGN**

The Heritage window system offers a modern thermally broken alternative to old steel windows, specifically designed with slim sightlines, attractive contours and enhanced thermal performance.

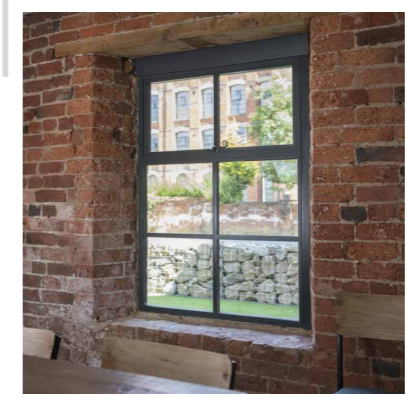

**HIGH PERFORMANCE**

Protect your home from the elements and any would be intruders with a traditional window design. Our Heritage collection utilises a cutting-edge approach throughout.



**WEATHERPROOF**

To ensure a warmer and more comfortable home throughout the year, these windows utilise high performance weather seals to eliminate draughts.



Anthracite grey tilt & turn window.

### KEY FEATURES

- Slim and stylish square internal bead
- Hidden gearing and hinges for added security
- Available in dual colour
- Max height and width of 1700 x 2100 as a single opener
- 65mm frame depth
- Available with a 1.1 U-value W/m<sup>2</sup>K - WER 'A'

# TILT & TURN RANGE

## WHAT IS A TILT & TURN WINDOW?

Aluminium tilt & turn windows are characterised by a 'tilt' function, which means the window can open on a 90° angle without compromising the locking system. They stand out as a unique window design, effortlessly enhancing functionality and home comfort.



Air  
600Pa



Water  
900Pa



Wind  
2400Pa



Anthracite grey tilt & turn window.



## CONTEMPORARY DESIGN

Our tilt & turn range offers a warm contemporary feel, aesthetically pleasing to the eye with a flush finish, they also have great thermal properties with an innovative polyamide thermal break.

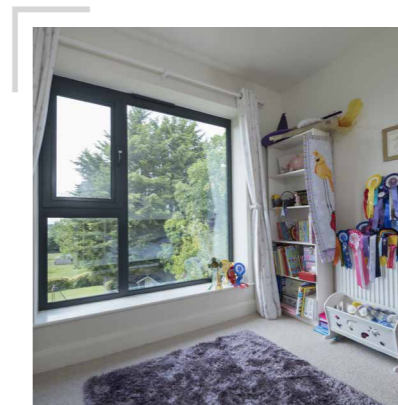

## LEADING PERFORMANCE

Designed for today's standards, our aluminium tilt & turn windows enhance any property with impressive levels of security, thermal efficiency, and lifespan for lasting quality.

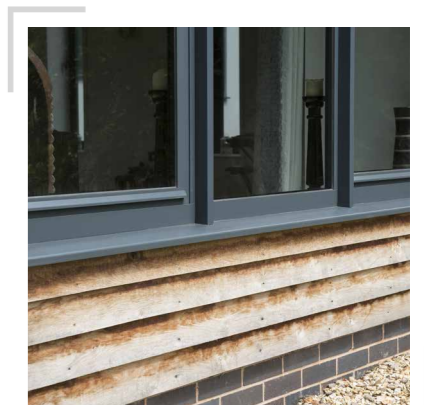

## WEATHERPROOFED

Keeping the elements at bay is important to maintaining a comfortable home, which is why we ensure all of our tilt & turn windows prevent draughts and water ingress.



myALI FRAMING SOLUTIONS